

## HIGHLIGHTS OF PRESCRIBING INFORMATION

These highlights do not include all the information needed to use AFREZZA® safely and effectively. See full prescribing information for AFREZZA®.

AFREZZA® (insulin human) inhalation powder, for oral inhalation use  
Initial U.S. Approval: 2014

### WARNING: RISK OF ACUTE BRONCHOSPASM IN PATIENTS WITH CHRONIC LUNG DISEASE

See full prescribing information for complete boxed warning.

- Acute bronchospasm has been observed in patients with asthma and COPD using AFREZZA. (5.1)
- AFREZZA is contraindicated in patients with chronic lung disease such as asthma or COPD. (4)
- Before initiating AFREZZA, perform a detailed medical history, physical examination, and spirometry (FEV<sub>1</sub>) to identify potential lung disease in all patients. (2.5), (5.1)

## INDICATIONS AND USAGE

- AFREZZA® is a rapid acting inhaled insulin indicated to improve glycemic control in adult patients with diabetes mellitus. (1)

Important limitations of use:

- In patients with type 1 diabetes, must use with a long-acting insulin (1)
- Not recommended for the treatment of diabetic ketoacidosis (1)
- Not recommended in patients who smoke (1)

## DOSAGE AND ADMINISTRATION

- Administer using a single inhalation per cartridge (2.1)
- Administer at the beginning of a meal (2.2)
- Dosing must be individualized (2.2)
- Before initiating, perform a detailed medical history, physical examination, and spirometry (FEV<sub>1</sub>) in all patients to identify potential lung disease (2.5)

## DOSAGE FORMS AND STRENGTHS

AFREZZA is available as single-use cartridges of: (3)

- 4 units
- 8 units
- 12 units

## CONTRAINDICATIONS

- During episodes of hypoglycemia (4)
- Chronic lung disease, such as asthma, or chronic obstructive pulmonary disease (4)
- Hypersensitivity to regular human insulin or any of the AFREZZA excipients (4)

## WARNINGS AND PRECAUTIONS

- **Acute Bronchospasm:** Acute bronchospasm has been observed in patients with asthma and COPD. Before initiating, perform spirometry (FEV<sub>1</sub>) in all patients. Do not use in patients with chronic lung disease. (2.5, 4, 5.1)
- **Change in Insulin Regimen:** Carry out under close medical supervision and increase frequency of blood glucose monitoring. (5.2)
- **Hypoglycemia:** May be life-threatening. Increase frequency of glucose monitoring with changes to: insulin dosage, co-administered glucose lowering medications, meal pattern, physical activity; and in patients with renal or hepatic impairment and hypoglycemia unawareness. (5.3, 6, 7, 8.6, 8.7)
- **Decline in Pulmonary Function:** Assess pulmonary function (e.g., spirometry) before initiating, after 6 months of therapy, and annually, even in the absence of pulmonary symptoms. (2.5, 5.4)
- **Lung Cancer:** AFREZZA should not be used in patients with active lung cancer. In patients with a history of lung cancer or at risk for lung cancer, the benefit of AFREZZA use should outweigh this potential risk. (5.5)
- **Diabetic Ketoacidosis:** More patients using AFREZZA experienced diabetic ketoacidosis in clinical trials. In patients at risk for DKA, monitor and change to alternate route of insulin delivery, if indicated. (5.6)
- **Hypersensitivity Reactions:** Severe, life-threatening, generalized allergy, including anaphylaxis, can occur with insulin products, including AFREZZA. Discontinue AFREZZA, monitor and treat if indicated. (5.7)
- **Hypokalemia:** May be life-threatening. Monitor potassium levels in patients at risk of hypokalemia and treat if indicated. (5.8)
- **Fluid Retention and Heart Failure with Concomitant Use of Thiazolidinediones (TZDs):** Observe for signs and symptoms of heart failure; consider dosage reduction or discontinuation if heart failure occurs. (5.9)

## ADVERSE REACTIONS

The most common adverse reactions associated with AFREZZA (2% or greater incidence) are hypoglycemia, cough, and throat pain or irritation (6)

To report SUSPECTED ADVERSE REACTIONS, contact MannKind at 1-877-323-8505 or FDA at 1-800-FDA-1088 or [www.fda.gov/medwatch](http://www.fda.gov/medwatch).

## DRUG INTERACTIONS

Drugs that Affect Glucose Metabolism: Adjustment of insulin dosage may be needed. (7.1, 7.2, 7.3)

Anti-Adrenergic Drugs (e.g., beta-blockers, clonidine, guanethidine, and reserpine): Signs and symptoms of hypoglycemia may be reduced or absent. (7.3, 7.4)

See 17 for Patient Counseling Information and Medication Guide.

Revised: 02/2020

## FULL PRESCRIBING INFORMATION: CONTENTS\*

### WARNING: RISK OF ACUTE BRONCHOSPASM IN PATIENTS WITH CHRONIC LUNG DISEASE

#### 1 INDICATIONS AND USAGE

#### 2 DOSAGE AND ADMINISTRATION

- 2.1 Route of Administration
- 2.2 Dosage Information
- 2.3 AFREZZA Administration for Doses Exceeding 12 units
- 2.4 Dosage Adjustment due to Drug Interactions
- 2.5 Lung Function Assessment Prior to Administration
- 2.6 Important Administration Instructions

#### 3 DOSAGE FORMS AND STRENGTHS

#### 4 CONTRAINDICATIONS

#### 5 WARNINGS AND PRECAUTIONS

- 5.1 Acute Bronchospasm in Patients with Chronic Lung Disease
- 5.2 Changes in Insulin Regimen
- 5.3 Hypoglycemia
- 5.4 Decline in Pulmonary Function
- 5.5 Lung Cancer
- 5.6 Diabetic Ketoacidosis
- 5.7 Hypersensitivity Reactions
- 5.8 Hypokalemia
- 5.9 Fluid Retention and Heart Failure with Concomitant Use of PPAR-gamma Agonists

**6 ADVERSE REACTIONS**

- 6.1 Clinical Trials Experience
- 6.2 Postmarketing Experience

**7 DRUG INTERACTIONS**

- 7.1 Drugs That May Increase the Risk of Hypoglycemia
- 7.2 Drugs That May Decrease the Blood Glucose Lowering Effect of AFREZZA
- 7.3 Drugs That May Increase or Decrease the Blood Glucose Lowering Effect of AFREZZA
- 7.4 Drugs That May Affect Hypoglycemia Signs and Symptoms

**8 USE IN SPECIFIC POPULATIONS**

- 8.1 Pregnancy
- 8.2 Lactation
- 8.4 Pediatric Use
- 8.5 Geriatric Use
- 8.6 Hepatic Impairment
- 8.7 Renal Impairment

**10 OVERDOSAGE****11 DESCRIPTION**

- 11.1 AFREZZA Cartridges
- 11.2 AFREZZA Inhaler

**12 CLINICAL PHARMACOLOGY**

- 12.1 Mechanism of Action
- 12.2 Pharmacodynamics
- 12.3 Pharmacokinetics

**13 NONCLINICAL TOXICOLOGY**

- 13.1 Carcinogenesis, Mutagenesis, Impairment of Fertility

**14 CLINICAL STUDIES**

- 14.1 Overview of Clinical Studies of AFREZZA for Diabetes Mellitus
- 14.2 Type 1 Diabetes
- 14.3 Type 2 Diabetes

**16 HOW SUPPLIED/STORAGE AND HANDLING****17 PATIENT COUNSELING INFORMATION**

\*Sections or subsections omitted from the full prescribing information are not listed.

**FULL PRESCRIBING INFORMATION**

**WARNING: RISK OF ACUTE BRONCHOSPASM IN PATIENTS WITH CHRONIC LUNG DISEASE**

- Acute bronchospasm has been observed in patients with asthma and COPD using AFREZZA [see *Warnings and Precautions (5.1)*].
- AFREZZA is contraindicated in patients with chronic lung disease such as asthma or COPD [see *Contraindications (4)*].
- Before initiating AFREZZA, perform a detailed medical history, physical examination, and spirometry (FEV<sub>1</sub>) to identify potential lung disease in all patients [see *Dosage and Administration (2.5), Warnings and Precautions (5.1)*].

**1 INDICATIONS AND USAGE**

AFREZZA® is a rapid acting inhaled insulin indicated to improve glycemic control in adult patients with diabetes mellitus.

**Limitations of Use**

- AFREZZA is not a substitute for long-acting insulin. AFREZZA must be used in combination with long-acting insulin in patients with type 1 diabetes mellitus.
- AFREZZA is not recommended for the treatment of diabetic ketoacidosis [see *Warning and Precautions (5.6)*].
- The safety and efficacy of AFREZZA in patients who smoke have not been established. The use of AFREZZA is not recommended in patients who smoke or who have recently stopped smoking.

**2 DOSAGE AND ADMINISTRATION**

**2.1 Route of Administration**

AFREZZA should only be administered via oral inhalation using the AFREZZA Inhaler. AFREZZA is administered using a single inhalation per cartridge.

**2.2 Dosage Information**

Administer AFREZZA at the beginning of the meal.

Dosage adjustment may be needed when switching from another insulin to AFREZZA [see *Warnings and Precautions (5.2)*].

**Step 1: Starting Mealtime Dose**

- Insulin Naïve Individuals: Start on 4 units of AFREZZA at each meal.
- Individuals Using Subcutaneous Mealtime (Prandial) Insulin: Determine the appropriate AFREZZA dose for each meal by converting from the injected dose using Figure 1.
- Individuals Using Subcutaneous Pre-mixed Insulin: Estimate the mealtime injected dose by dividing half of the total daily injected pre-mixed insulin dose equally among the three meals of the day. Convert each estimated injected mealtime dose to an appropriate AFREZZA dose using Figure 1. Administer half of the total daily injected pre-mixed dose as an injected basal insulin dose.











**Step 2: Mealtime Dose Adjustment**

Adjust the dosage of AFREZZA based on the individual's metabolic needs, glucose monitoring results and glycemic control goal.

Dosage adjustments may be needed with changes in physical activity, changes in meal patterns (i.e., macronutrient content or timing of food intake), changes in renal or hepatic function or during acute illness [see *Warnings and Precautions (5.3), Use in Specific Populations (8.6, 8.7)*].

Carefully monitor blood glucose control in patients requiring high doses of AFREZZA. If, in these patients, blood glucose control is not achieved with increased AFREZZA doses, consider use of subcutaneous mealtime insulin.

**Figure 1. Mealtime AFREZZA Starting Dose Conversion Table**

| Injected Mealtime Insulin Dose | AFREZZA® Dose | # of cartridges needed  |   |  |
|--------------------------------|---------------|---|---|--|
|                                |               | 4 unit (blue)   | 8 unit (green)  | 12 unit (yellow)   |
| up to 4 units                  | 4 units       |  |   |  |
| 5-8 units                      | 8 units       |   |  |  |
| 9-12 units                     | 12 units      |  | +   |  or  |
| 13-16 units                    | 16 units      |   |   |       |
| 17-20 units                    | 20 units      |   |   |  +   |
| 21-24 units                    | 24 units      |   |   |    |

**2.3 AFREZZA Administration for Doses Exceeding 12 units**

For AFREZZA doses exceeding 12 units, inhalations from multiple cartridges are necessary. To achieve the required total mealtime dose, patients should use a combination of 4 unit, 8 unit and 12 unit cartridges. Examples of cartridge combinations for doses of up to 24 units are shown in Figure 1. For doses above 24 units, combinations of different multiple cartridges can be used.

## 2.4 Dosage Adjustment due to Drug Interactions

Dosage adjustment may be needed when AFREZZA is coadministered with certain drugs [see *Drug Interactions (7)*].

## 2.5 Lung Function Assessment Prior to Administration

AFREZZA is contraindicated in patients with chronic lung disease because of the risk of acute bronchospasm in these patients. Before initiating AFREZZA, perform a medical history, physical examination and spirometry (FEV<sub>1</sub>) in all patients to identify potential lung disease [see *Contraindications (4)* and *Warnings and Precautions (5.1)*].

## 2.6 Important Administration Instructions

See Patient Instructions for Use for complete administration instructions with illustrations.

Keep the inhaler level with the white mouthpiece on top and purple base on the bottom after a cartridge has been inserted into the inhaler. Loss of drug effect can occur if the inhaler is turned upside down, held with the mouthpiece pointing down, shaken (or dropped) after the cartridge has been inserted but before the dose has been administered. If any of the above occur, the cartridge should be replaced before use.

## 3 DOSAGE FORMS AND STRENGTHS

AFREZZA (insulin human) Inhalation Powder is available as 4 unit, 8 unit and 12 unit single use cartridges to be administered via oral inhalation with the AFREZZA Inhaler only [see *How Supplied/Storage and Handling (16)*].

## 4 CONTRAINDICATIONS

AFREZZA is contraindicated in patients with the following:

- During episodes of hypoglycemia
- Chronic lung disease, such as asthma or chronic obstructive pulmonary disease (COPD), because of the risk of acute bronchospasm [see *Warnings and Precautions (5.1)*]
- Hypersensitivity to regular human insulin or any of the AFREZZA excipients [see *Warnings and Precautions (5.7)*]

## 5 WARNINGS AND PRECAUTIONS

### 5.1 Acute Bronchospasm in Patients with Chronic Lung Disease

Because of the risk of acute bronchospasm, AFREZZA is contraindicated in patients with chronic lung disease such as asthma or COPD [see *Contraindications (4)*].

Before initiating therapy with AFREZZA, evaluate all patients with a medical history, physical examination and spirometry (FEV<sub>1</sub>) to identify potential underlying lung disease.

Acute bronchospasm has been observed following AFREZZA dosing in patients with asthma and patients with COPD. In a study of patients with asthma, bronchoconstriction and wheezing following AFREZZA dosing was reported in 29% (5 out of 17) and 0% (0 out of 13) of patients with and without a diagnosis of asthma, respectively. In this study, a mean decline in FEV<sub>1</sub> of 400 mL was observed 15 minutes after a single dose in patients with asthma. In a study of patients with COPD (n=8), a mean decline in FEV<sub>1</sub> of 200 mL was observed 18 minutes after a single dose of AFREZZA. The long-term safety and efficacy of AFREZZA in patients with chronic lung disease have not been established.

### 5.2 Changes in Insulin Regimen

Glucose monitoring is essential for patients receiving insulin therapy. Changes in insulin strength, manufacturer, type, or method of administration may affect glycemic control and predispose to hypoglycemia [see *Warnings and Precautions (5.3)*] or hyperglycemia. These changes should be made under close medical supervision and the frequency of blood glucose monitoring should be increased. Concomitant oral antidiabetic treatment may need to be adjusted.

### 5.3 Hypoglycemia

Hypoglycemia is the most common adverse reaction associated with insulins, including AFREZZA. Severe hypoglycemia can cause seizures, may be life-threatening, or cause death. Hypoglycemia can impair concentration ability and reaction time; this may place an individual and others at risk in situations where these abilities are important (e.g., driving or operating other machinery).

The timing of hypoglycemia usually reflects the time-action profile of the administered insulin formulation. AFREZZA has a distinct time action profile [see *Clinical Pharmacology (12)*], which impacts the timing of hypoglycemia. Hypoglycemia can happen suddenly and symptoms may differ across individuals and change over time in the same individual. Symptomatic awareness of hypoglycemia may be less pronounced in patients with longstanding diabetes, in patients with diabetic nerve disease, in patients using certain medications [see *Drug Interactions (7)*], or in patients who experience recurrent hypoglycemia. Other factors which may increase the risk of hypoglycemia include changes in meal pattern (e.g., macronutrient content or timing of meals), changes in level of physical activity, or changes to co-administered medication [see *Drug Interactions (7)*]. Patients with renal or hepatic impairment may be at higher risk of hypoglycemia [see *Use in Specific Populations (8.6, 8.7)*].

#### Risk Mitigation Strategies for Hypoglycemia

Patients and caregivers must be educated to recognize and manage hypoglycemia. Self-monitoring of blood glucose plays an essential role in the prevention and management of hypoglycemia. In patients at higher risk for hypoglycemia and patients who have reduced symptomatic awareness of hypoglycemia, increased frequency of blood glucose monitoring is recommended.

### 5.4 Decline in Pulmonary Function

AFREZZA causes a decline in lung function over time as measured by FEV<sub>1</sub>. In clinical trials excluding patients with chronic lung disease and lasting up to 2 years, AFREZZA-treated patients experienced a small [40 mL (95% CI: -80, -1)] but greater FEV<sub>1</sub> decline than comparator-treated patients. The FEV<sub>1</sub> decline was noted within the first 3 months, and persisted for the entire duration of therapy (up to 2 years of observation). In this population, the annual rate of FEV<sub>1</sub> decline did not appear to worsen with increased duration of use. The effects of AFREZZA on pulmonary function for treatment duration longer than 2 years has not been established. There are insufficient data in long term studies to draw conclusions regarding reversal of the effect on FEV<sub>1</sub> after discontinuation of AFREZZA. The observed changes in FEV<sub>1</sub> were similar in patients with type 1 and type 2 diabetes.

Assess pulmonary function (e.g., spirometry) at baseline, after the first 6 months of therapy, and annually thereafter, even in the absence of pulmonary symptoms. In patients who have a decline of  $\geq 20\%$  in FEV<sub>1</sub> from baseline, consider discontinuing AFREZZA. Consider more frequent monitoring of pulmonary function in patients with pulmonary symptoms such as wheezing, bronchospasm, breathing difficulties, or persistent or recurring cough. If symptoms persist, discontinue AFREZZA [see *Adverse Reactions* (6)].

### 5.5 Lung Cancer

In clinical trials, two cases of lung cancer, one in controlled trials and one in uncontrolled trials (2 cases in 2,750 patient-years of exposure), were observed in participants exposed to AFREZZA while no cases of lung cancer were observed in comparators (0 cases in 2,169 patient-years of exposure). In both cases, a prior history of heavy tobacco use was identified as a risk factor for lung cancer. Two additional cases of lung cancer (squamous cell and lung blastoma) occurred in non-smokers exposed to AFREZZA and were reported by investigators after clinical trial completion. These data are insufficient to determine whether AFREZZA has an effect on lung or respiratory tract tumors. In patients with active lung cancer, a prior history of lung cancer, or in patients at risk for lung cancer, consider whether the benefits of AFREZZA use outweigh this potential risk.

### 5.6 Diabetic Ketoacidosis

In clinical trials enrolling subjects with type 1 diabetes, diabetic ketoacidosis (DKA) was more common in subjects receiving AFREZZA (0.43%; n=13) than in subjects receiving comparators (0.14%; n=3). In patients at risk for DKA, such as those with an acute illness or infection, increase the frequency of glucose monitoring and consider delivery of insulin using an alternate route of administration if indicated [see *Indications and Usage* (1)].

### 5.7 Hypersensitivity Reactions

Severe, life-threatening, generalized allergy, including anaphylaxis, can occur with insulin products, including AFREZZA. If hypersensitivity reactions occur, discontinue AFREZZA, treat per standard of care and monitor until symptoms and signs resolve [see *Adverse Reactions* (6)]. AFREZZA is contraindicated in patients who have had hypersensitivity reactions to AFREZZA or any of its excipients [see *Contraindications* (4)].

### 5.8 Hypokalemia

All insulin products, including AFREZZA, cause a shift in potassium from the extracellular to intracellular space, possibly leading to hypokalemia. Untreated hypokalemia may cause respiratory paralysis, ventricular arrhythmia, and death. Monitor potassium levels in patients at risk for hypokalemia (e.g., patients using potassium-lowering medications, patients taking medications sensitive to serum potassium concentrations and patients receiving intravenously administered insulin).

### 5.9 Fluid Retention and Heart Failure with Concomitant Use of PPAR-gamma Agonists

Thiazolidinediones (TZDs), which are peroxisome proliferator-activated receptor (PPAR)-gamma agonists, can cause dose-related fluid retention, particularly when used in combination with insulin. Fluid retention may lead to or exacerbate heart failure. Patients treated with insulin, including AFREZZA, and a PPAR-gamma agonist should be observed for signs and symptoms of heart failure. If heart failure develops, it should be managed according to current standards of care, and discontinuation or dose reduction of the PPAR-gamma agonist must be considered.

## 6 ADVERSE REACTIONS

The following serious adverse reactions are described below and elsewhere in the labeling:

- Acute bronchospasm in patients with chronic lung disease [see *Warnings and Precautions* (5.1)]
- Hypoglycemia [see *Warnings and Precautions* (5.3)]
- Decline in pulmonary function [see *Warnings and Precautions* (5.4)]
- Lung cancer [see *Warnings and Precautions* (5.5)]
- Diabetic ketoacidosis [see *Warnings and Precautions* (5.6)]
- Hypersensitivity reactions [see *Warnings and Precautions* (5.7)]

### 6.1 Clinical Trials Experience

Because clinical trials are conducted under widely varying conditions, adverse reaction rates observed in the clinical trials of a drug cannot be directly compared to rates in the clinical trials of another drug and may not reflect the rates observed in practice.

The data described below reflect exposure of 3017 patients to AFREZZA and include 1026 patients with type 1 diabetes and 1991 patients with type 2 diabetes. The mean exposure duration was 8.17 months for the overall population and 8.16 months and 8.18 months for type 1 and 2 diabetes patients, respectively. In the overall population, 1874 were exposed to AFREZZA for 6 months and 724 for greater than one year. 620 and 1254 patients with type 1 and type 2 diabetes, respectively, were exposed to AFREZZA for up to 6 months. 238 and 486 patients with type 1 and type 2 diabetes, respectively, were exposed to AFREZZA for greater than one year (median exposure = 1.8 years). AFREZZA was studied in placebo and active-controlled trials (n = 3 and n = 10, respectively).

The mean age of the population was 50.2 years and 20 patients were older than 75 years of age. 50.8% of the population were men; 82.6% were White, 1.8% were Asian, and 4.9% were Black or African American. 9.7% were Hispanic. At baseline, the type 1 diabetes population had diabetes for an average of 16.6 years and had a mean HbA1c of 8.3%, and the type 2 diabetes population had diabetes for an average of 10.7 years and had a mean HbA1c of 8.8%. At baseline, 33.4% of the population reported peripheral neuropathy, 32.0% reported retinopathy and 19.6% had a history of cardiovascular disease.

Table 1 shows common adverse reactions, excluding hypoglycemia, associated with the use of AFREZZA in the pool of controlled trials in type 2 diabetes patients. These adverse reactions were not present at baseline, occurred more commonly on AFREZZA than on placebo and/or comparator and occurred in at least 2% of patients treated with AFREZZA.

**Table 1. Common Adverse Reactions in Patients with Type 2 Diabetes Mellitus (excluding Hypoglycemia) Treated with AFREZZA**

|                           | Placebo*<br>(n = 290) | AFREZZA<br>(n = 1991) | Non-placebo<br>comparators (n=1363) |
|---------------------------|-----------------------|-----------------------|-------------------------------------|
| Cough                     | 19.7%                 | 25.6%                 | 5.4%                                |
| Throat pain or irritation | 3.8%                  | 4.4%                  | 0.9%                                |
| Headache                  | 2.8%                  | 3.1%                  | 1.8%                                |
| Diarrhea                  | 1.4%                  | 2.7%                  | 2.2%                                |
| Productive cough          | 1.0%                  | 2.2%                  | 0.9%                                |
| Fatigue                   | 0.7%                  | 2.0%                  | 0.6%                                |
| Nausea                    | 0.3%                  | 2.0%                  | 1.0%                                |

\*Carrier particle without insulin was used as placebo [see Description (11.1)].

Table 2 shows common adverse reactions, excluding hypoglycemia, associated with the use of AFREZZA in the pool of active-controlled trials in type 1 diabetes patients. These adverse reactions were not present at baseline, occurred more commonly on AFREZZA than on comparator, and occurred in at least 2% of patients treated with AFREZZA.

**Table 2. Common Adverse Reactions in Patients with Type 1 Diabetes Mellitus (excluding Hypoglycemia) Treated with AFREZZA**

|                                   | Subcutaneous Insulin<br>(n = 835) | AFREZZA<br>(n=1026) |
|-----------------------------------|-----------------------------------|---------------------|
| Cough                             | 4.9%                              | 29.4%               |
| Throat pain or irritation         | 1.9%                              | 5.5%                |
| Headache                          | 2.8%                              | 4.7%                |
| Pulmonary function test decreased | 1.0%                              | 2.8%                |
| Bronchitis                        | 2.0%                              | 2.5%                |
| Urinary tract infection           | 1.9%                              | 2.3%                |

Hypoglycemia

Hypoglycemia is the most commonly observed adverse reaction in patients using insulin, including AFREZZA [see Warnings and Precautions (5.3)]. The incidence of severe and non-severe hypoglycemia of AFREZZA versus placebo in patients with type 2 diabetes is shown in Table 3. A hypoglycemic episode was recorded if a patient reported symptoms of hypoglycemia with or without a blood glucose value consistent with hypoglycemia. Severe hypoglycemia was defined as an event with symptoms consistent with hypoglycemia requiring the assistance of another person and associated with either a blood glucose value consistent with hypoglycemia or prompt recovery after treatment for hypoglycemia.

**Table 3. Incidence of Severe and Non-Severe Hypoglycemia in a Placebo-Controlled Study of Patients with Type 2 Diabetes**

|                         | Placebo<br>(N=176) | AFREZZA<br>(N=177) |
|-------------------------|--------------------|--------------------|
| Severe Hypoglycemia     | 1.7%               | 5.1%               |
| Non-Severe Hypoglycemia | 30%                | 67%                |

Cough

Approximately 27% of patients treated with AFREZZA reported cough, compared to approximately 5.2% of patients treated with comparator. In clinical trials, cough was the most common reason for discontinuation of AFREZZA therapy (2.8% of AFREZZA-treated patients).

Pulmonary Function Decline

In clinical trials lasting up to 2 years, excluding patients with chronic lung disease, patients treated with AFREZZA had a 40 mL (95% CI: -80, -1) greater decline from baseline in forced expiratory volume in one second (FEV<sub>1</sub>) compared to patients treated with comparator anti-diabetes treatments. The decline occurred during the first 3 months of therapy and persisted over 2 years (Figure 2). A decline in FEV<sub>1</sub> of ≥ 15% occurred in 6% of AFREZZA-treated subjects compared to 3% of comparator-treated subjects.

**Figure 2. Mean (+/-SE) Change in FEV<sub>1</sub> (Liters) from Baseline for Type 1 and Type 2 Diabetes Patients**

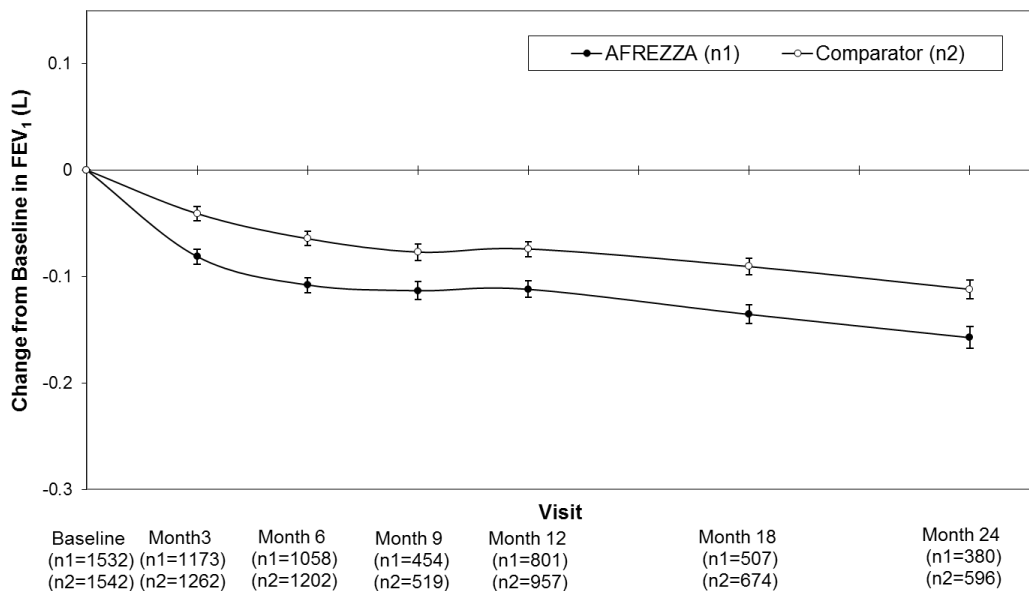

### Weight Gain

Weight gain may occur with some insulin therapies, including AFREZZA. Weight gain has been attributed to the anabolic effects of insulin and the decrease in glycosuria. In a clinical trial of patients with type 2 diabetes [see *Clinical Studies (14.3)*], there was a mean 0.49 kg weight gain among AFREZZA-treated patients compared with a mean 1.13 kg weight loss among placebo-treated patients.

### Antibody Production

Increases in anti-insulin antibody concentrations have been observed in patients treated with AFREZZA. Increases in anti-insulin antibodies are observed more frequently with AFREZZA than with subcutaneously injected mealtime insulins. Presence of antibody did not correlate with reduced efficacy, as measured by HbA1c and fasting plasma glucose, or specific adverse reactions.

## **6.2 Postmarketing Experience**

The following adverse reactions have been identified during post approval use of AFREZZA. Because these reactions are reported voluntarily from a population of uncertain size, it is not always possible to reliably estimate their frequency or establish a causal relationship to drug exposure: bronchospasm.

## **7 DRUG INTERACTIONS**

### **7.1 Drugs That May Increase the Risk of Hypoglycemia**

The risk of hypoglycemia associated with AFREZZA use may be increased with antidiabetic agents, ACE inhibitors, angiotensin II receptor blocking agents, disopyramide, fibrates, fluoxetine, monoamine oxidase inhibitors, pentoxifylline, pramlintide, propoxyphene, salicylates, somatostatin analogs (e.g., octreotide), and sulfonamide antibiotics. Dose adjustment and increased frequency of glucose monitoring may be required when AFREZZA is co-administered with these drugs.

### **7.2 Drugs That May Decrease the Blood Glucose Lowering Effect of AFREZZA**

The glucose lowering effect of AFREZZA may be decreased when co-administered with atypical antipsychotics (e.g., olanzapine and clozapine), corticosteroids, danazol, diuretics, estrogens, glucagon, isoniazid, niacin, oral contraceptives, phenothiazines, progestogens (e.g., in oral contraceptives), protease inhibitors, somatropin, sympathomimetic agents (e.g., albuterol, epinephrine, terbutaline) and thyroid hormones. Dose adjustment and increased frequency of glucose monitoring may be required when AFREZZA is co-administered with these drugs.

### **7.3 Drugs That May Increase or Decrease the Blood Glucose Lowering Effect of AFREZZA**

The glucose lowering effect of AFREZZA may be increased or decreased when co-administered with alcohol, beta-blockers, clonidine, and lithium salts. Pentamidine may cause hypoglycemia, which may sometimes be followed by hyperglycemia. Dose adjustment and increased frequency of glucose monitoring may be required when AFREZZA is co-administered with these drugs.

### **7.4 Drugs That May Affect Hypoglycemia Signs and Symptoms**

The signs and symptoms of hypoglycemia may be blunted when beta-blockers, clonidine, guanethidine, and reserpine are co-administered with AFREZZA.

## **8 USE IN SPECIFIC POPULATIONS**

### **8.1 Pregnancy**

#### Risk Summary

Limited available data with AFREZZA use in pregnant women are insufficient to determine drug-associated risks for adverse developmental outcomes. Available information from published studies with human insulin use during pregnancy has not reported a clear association with human insulin and adverse developmental outcomes (see Data). There are risks to the mother and fetus associated with poorly controlled diabetes in pregnancy (see Clinical Considerations). In animal reproduction studies, there were no adverse developmental outcomes with subcutaneous administration of carrier particles (vehicle without insulin) to pregnant rats during organogenesis at doses 14-21 times the maximum recommended daily dose (see Data).

The estimated background risk of major birth defects is 6-10% in women with pre-gestational diabetes with HbA1c >7 and has been reported to be as high as 20-25% in women with HbA1c >10. The estimated background risk of miscarriage for the indicated population is unknown. In the U.S. general population, the estimated background risk of major birth defects and miscarriage in clinically recognized pregnancies is 2-4% and 15-20%, respectively.

#### Clinical Considerations

##### *Disease-associated maternal and/or embryo/fetal risk*

Poorly controlled diabetes in pregnancy increases the maternal risk for diabetic ketoacidosis, pre-eclampsia, spontaneous abortions, preterm delivery, stillbirth, and delivery complications. Poorly controlled diabetes increases the fetal risk for major birth defects, still birth, and macrosomia-related morbidity.

#### Data

##### *Human Data*

There are limited data with AFREZZA use in pregnant women. Published data do not report a clear association with human insulin and major birth defects, miscarriage, or adverse maternal or fetal outcomes when human insulin is used during pregnancy. However, these studies cannot definitely establish the absence of any risk because of methodological limitations including small sample size and lack of blinding.

##### *Animal Data*

In pregnant rats given subcutaneous doses of 10, 30, and 100 mg/kg/day of carrier particles (vehicle without insulin) from gestation day 6 through 17 (organogenesis), no major malformations were observed at up to 100 mg/kg/day (a systemic exposure 14-21 times the human systemic exposure, resulting from the maximum recommended daily dose of 99 mg AFREZZA based on AUC).

In pregnant rabbits given subcutaneous doses of 2, 10, and 100 mg/kg/day of carrier particles (vehicle without insulin) from gestation day 7 through 19 (organogenesis), adverse maternal effects were observed at all dose groups (at human systemic exposure following a 99 mg AFREZZA dose, based on AUC).

In pregnant rats given subcutaneous doses of 10, 30, and 100 mg/kg/day of carrier particles (vehicle without insulin) from gestation day 7 through lactation day 20 (weaning), decreased epididymis and testes weights, however, no decrease in fertility was noted, and impaired learning were observed in pups at  $\geq 30$  mg/kg/day (a systemic exposure 6 times human systemic exposure at the maximum daily AFREZZA dose of 99 mg based on AUC).

## 8.2 Lactation

### Risk Summary

There are no data on the presence of AFREZZA in human milk, the effects on the breastfed infant, or the effects on milk production. One small published study reported that exogenous insulin was present in human milk. No adverse effects in infants were noted. The carrier particles are present in rat milk (see Data). Potential adverse effects that are related to inhalational administration of AFREZZA are unlikely to be associated with potential exposure of AFREZZA through breast milk. The developmental and health benefits of breastfeeding should be considered along with the mother's clinical need for AFREZZA and any potential adverse effects on the breastfed infant from AFREZZA or from the underlying maternal condition.

### Data

Subcutaneous administration of the carrier particle in lactating rats resulted in excretion of the carrier particle in rat milk at levels that were approximately 10% of the maternal exposure. Given the results of the rat study, it is highly likely that the insulin and carrier in AFREZZA are excreted in human milk.

## 8.4 Pediatric Use

AFREZZA has not been studied in patients younger than 18 years of age.

## 8.5 Geriatric Use

In the AFREZZA clinical studies, 381 patients were 65 years of age or older, of which 20 were 75 years of age or older. No overall differences in safety or effectiveness were observed between patients over 65 and younger patients.

Pharmacokinetic/pharmacodynamic studies to assess the effect of age have not been conducted.

## 8.6 Hepatic Impairment

The effect of hepatic impairment on the pharmacokinetics of AFREZZA has not been studied. Frequent glucose monitoring and dose adjustment may be necessary for AFREZZA in patients with hepatic impairment [see Warnings and Precautions (5.3)].

## 8.7 Renal Impairment

The effect of renal impairment on the pharmacokinetics of AFREZZA has not been studied. Some studies with human insulin have shown increased circulating levels of insulin in patients with renal failure. Frequent glucose monitoring and dose adjustment may be necessary for AFREZZA in patients with renal impairment [see Warnings and Precautions (5.3)].

## 10 OVERDOSAGE

Excess insulin administration may cause hypoglycemia and hypokalemia [see Warnings and Precautions (5.3, 5.8)].

Mild episodes of hypoglycemia can usually be treated with oral glucose. Adjustments in drug dosage, meal patterns, or exercise, may be needed.

Severe episodes of hypoglycemia with coma, seizure, or neurologic impairment may be treated with intramuscular / subcutaneous glucagon or concentrated intravenous glucose. After apparent clinical recovery from hypoglycemia, continued observation and additional carbohydrate intake may be necessary to avoid recurrence of hypoglycemia. Hypokalemia must be corrected appropriately.

## 11 DESCRIPTION

### 11.1 AFREZZA Cartridges

AFREZZA consists of single-use plastic cartridges filled with a white powder containing insulin (human), which is administered via oral inhalation using the AFREZZA Inhaler only.

AFREZZA cartridges contain human insulin produced by recombinant DNA technology utilizing a non-pathogenic laboratory strain of Escherichia coli (K12). Chemically, human insulin has the empirical formula C<sub>257</sub>H<sub>383</sub>N<sub>65</sub>O<sub>77</sub>S<sub>6</sub> and a molecular weight of 5808. Human insulin has the following primary amino acid sequence:

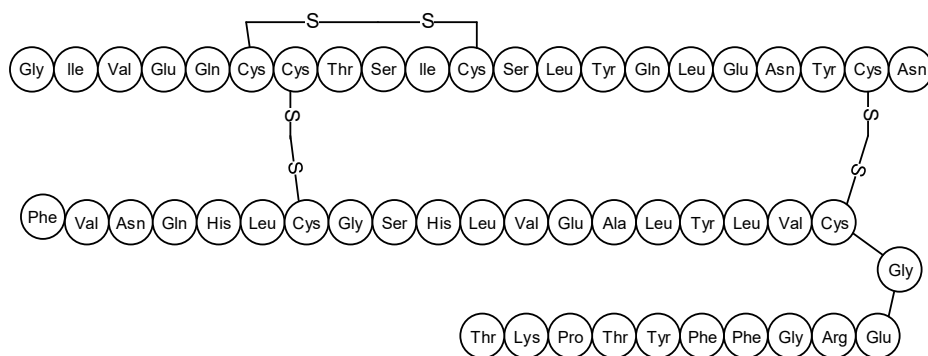

Insulin is adsorbed onto carrier particles consisting of fumaryl diketopiperazine (FDKP) and polysorbate 80.

AFREZZA Inhalation Powder is a dry powder supplied as 4 unit, 8 unit or 12 unit cartridges. The 4 unit cartridge contains 0.35 mg of insulin. The 8 unit cartridge contains 0.7 mg of insulin. The 12 unit cartridge contains 1 mg of insulin.

### 11.2 AFREZZA Inhaler

The AFREZZA Inhaler is breath-powered by the patient. When the patient inhales through the device, the powder is aerosolized and delivered to the lung. The amount of AFREZZA delivered to the lung will depend on individual patient factors.



## 12 CLINICAL PHARMACOLOGY

### 12.1 Mechanism of Action

Insulin lowers blood glucose levels by stimulating peripheral glucose uptake by skeletal muscle and fat, and by inhibiting hepatic glucose production. Insulin inhibits lipolysis in adipocytes, inhibits proteolysis, and enhances protein synthesis.

### 12.2 Pharmacodynamics

The time course of insulin action (i.e., glucose lowering) may vary considerably in different individuals or within the same individual. The average pharmacodynamic profile [i.e., glucose lowering effect measured by glucose infusion rate (GIR) over time in a euglycemic clamp study] for a single 4, 12, and 48 unit dose of AFREZZA in 30 patients with type 1 diabetes is shown in Figure 3(A), and key characteristics surrounding the timing of the effects are described in Table 4:

**Table 4. Timing of insulin effect (i.e., mean pharmacodynamics effect) after administration for a single dose of 4, 12, and 48 units of AFREZZA in patients (N=30) with T1DM and corresponding to the data shown in Figure 3(A)**

| Parameter for Insulin Effect          | AFREZZA 4 units | AFREZZA 12 units | AFREZZA 48 units |
|---------------------------------------|-----------------|------------------|------------------|
| Time to first measurable effect       | ~12 minutes     | ~12 minutes      | ~12 minutes      |
| Time to peak effect                   | ~35 minutes     | ~45 minutes      | ~55 minutes      |
| Time for effect to return to baseline | ~90 minutes     | ~180 minutes     | ~270 minutes     |

**Figure 3. Mean Insulin Effect (Baseline-Corrected Glucose Infusion Rate; A) and Pharmacokinetic (Baseline-Corrected Serum Insulin Concentrations; B) profiles after Administration of AFREZZA 4, 12, and 48 units in Type 1 Diabetes Patients (N=30)**

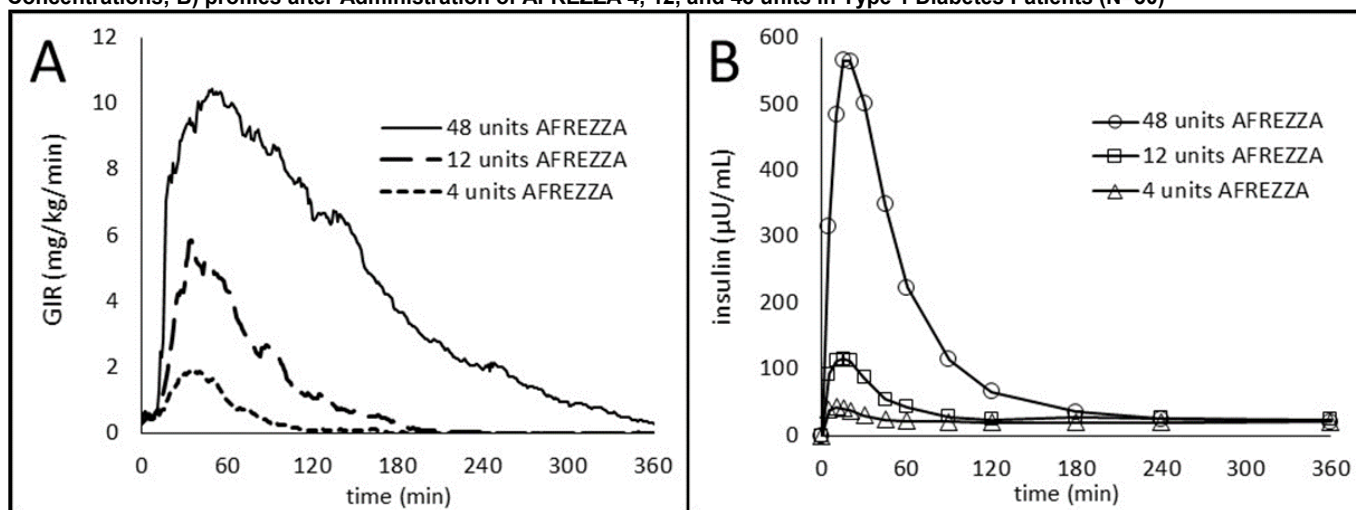

On average, the pharmacodynamics effect of AFREZZA, measured as area under the glucose infusion rate – time curve (AUC GIR) increased linearly with doses up to 48 units (106, 387, and 1581 mg/kg for 4, 12, and 48 units doses, respectively).

Inpatient variability in AUC GIR and  $GIR_{max}$  is approximately 28% (95% CI 21-42%) and 27% (95% CI 20-40%), respectively.

### 12.3 Pharmacokinetics

#### Absorption

The pharmacokinetic profiles for orally inhaled AFREZZA 4, 12, and 48 units from a study in 30 patients with type 1 diabetes are shown in Figure 3(B). The time to maximum serum insulin concentration ranges from 10-20 minutes after oral inhalation of 4 to 48 units of AFREZZA. Serum insulin concentrations declined to baseline by approximately 60 to 240 minutes for these dose levels.

#### Disposition

Systemic insulin disposition (apparent terminal half-life) following oral inhalation of 4 to 48 units of AFREZZA was 120-206 minutes.

#### Dose Proportionality

Insulin exposure (AUC) has been demonstrated to be dose-proportional when using AFREZZA doses up to 48 units.

#### Variability

Inpatient variability in insulin exposure measured by AUC and  $C_{max}$  is approximately 16% (95% CI 12-23%) and 21% (95% CI 16-30%), respectively.

#### Metabolism and Elimination

The metabolism and elimination of AFREZZA are comparable to regular human insulin.

#### Carrier Particles

Clinical pharmacology studies showed that carrier particles [see Description (11.1)] are not metabolized and are eliminated unchanged in the urine following the lung absorption. Following oral inhalation of AFREZZA, a mean of 39% of the inhaled dose of carrier particles was distributed to the lungs and a mean of 7% of the dose was swallowed. The swallowed fraction was not absorbed from the GI tract and was eliminated unchanged in the feces.

#### Drug Interaction: Bronchodilators and Inhaled Steroids

Albuterol increased the AUC insulin administered by AFREZZA by 25% in patients with asthma. Effect of fluticasone on insulin exposures following AFREZZA administration has not been evaluated in patients with asthma; however, no significant change in insulin exposure was observed in a study in healthy volunteers. Frequent glucose monitoring and dose reduction may be necessary for AFREZZA if it is co-administered with albuterol.

## 13 NONCLINICAL TOXICOLOGY

### 13.1 Carcinogenesis, Mutagenesis, Impairment of Fertility

In a 104 week carcinogenicity study, rats were given doses up to 46 mg/kg/day of the carrier and up to 1.23 mg/kg/day of insulin, by nose-only inhalation. No increased incidence of tumors was observed at systemic exposures equivalent to the insulin at a maximum daily AFREZZA dose of 99 mg based on a comparison of relative body surface areas across species.

No increased incidence of tumors was observed in a 26 week carcinogenicity study in transgenic mice (Tg-ras-H2) given doses up to 75 mg/kg/day of carrier and up to 5 mg/kg/day of AFREZZA.

AFREZZA was not genotoxic in Ames bacterial mutagenicity assay and in the chromosome aberration assay, using human peripheral lymphocytes with or without metabolic activation. The carrier alone was not genotoxic in the in vivo mouse micronucleus assay.

In female rats given subcutaneous doses of 10, 30, and 100 mg/kg/day of carrier (vehicle without insulin) beginning 2 weeks prior to mating until gestation day 7, there were no adverse effects on male fertility at doses up to 100 mg/kg/day (a systemic exposure 14-21 times that following the maximum daily AFREZZA dose of 99 mg based on AUC). In female rats there was increased pre- and post-implantation loss at 100 mg/kg/day but not at 30 mg/kg/day (14-21 times higher systemic exposure than the maximum daily AFREZZA dose of 99 mg based on AUC).

## 14 CLINICAL STUDIES

### 14.1 Overview of Clinical Studies of AFREZZA for Diabetes Mellitus

AFREZZA has been studied in adults with type 1 diabetes in combination with basal insulin. The efficacy of AFREZZA in type 1 diabetes patients was compared to insulin aspart in combination with basal insulin. AFREZZA has been studied in adults with type 2 diabetes in combination with oral antidiabetic drugs. The efficacy of AFREZZA in type 2 diabetes patients was compared to placebo inhalation.

### 14.2 Type 1 Diabetes

Patients with inadequately controlled type 1 diabetes participated in a 24-week, open-label, active-controlled study to evaluate the glucose lowering effect of mealtime AFREZZA used in combination with a basal insulin. Following a 4-week basal insulin optimization period, 344 patients were randomized to AFREZZA (n=174) or insulin aspart (n=170) administered at each meal of the day. Mealtime insulin doses were titrated to glycemic goals for the first 12 weeks and kept stable for the last 12 weeks of the study. At Week 24, treatment with basal insulin and mealtime AFREZZA provided a mean reduction in HbA1c that met the pre-specified non-inferiority margin of 0.4%. AFREZZA provided less HbA1c reduction than insulin aspart, and the difference was statistically significant. More subjects in the insulin aspart group achieved the HbA1c target of  $\leq 7\%$  (Table 5).

**Table 5. Results at Week 24 in an Active-Controlled Study of Mealtime AFREZZA plus Basal Insulin in Adults with Type 1 Diabetes**

| Efficacy Parameter  | AFREZZA + Basal Insulin<br>(N=174) | Insulin Aspart + Basal<br>Insulin<br>(N=170) |
|---|------------------------------------|--|
| HbA1c (%)   |                                    |  |
| Baseline (adjusted mean <sup>a</sup> )  | 7.94                               | 7.92   |
| Change from baseline (adjusted mean <sup>a,b</sup> )  | -0.21                              | -0.40  |
| Difference from insulin aspart (adjusted mean <sup>a,b</sup> )<br>(95% CI)  |                                    | 0.19<br>(0.02, 0.36)                         |
| Percentage of patients achieving HbA1c $\leq 7\%$ <sup>c</sup>  | 13.8                               | 27.1   |
| Fasting Plasma Glucose (mg/dL)  |                                    |  |
| Baseline (adjusted mean <sup>a</sup> )  | 153.9                              | 151.6  |
| Change from baseline (adjusted mean <sup>a,b</sup> )  | -25.3                              | 10.2   |
| Difference from insulin aspart (adjusted mean <sup>a,b</sup> )<br>(95% CI)  |                                    | -35.4<br>(-56.3, -14.6)                      |
| <sup>a</sup> Adjusted mean was obtained using a Mixed Model Repeated Measures (MMRM) approach with HbA1c or FPG as the dependent variable and treatment, visit, region, basal insulin stratum, and treatment by visit interaction as fixed factors, and corresponding baseline as a covariate. An autoregression (1) [AR(1)] covariance structure was used.<br><sup>b</sup> Data at 24 weeks were available from 131 (75 %) and 150 (88 %) subjects randomized to the AFREZZA and insulin aspart groups, respectively.<br><sup>c</sup> The percentage was calculated based on the number of patients randomized to the trial. |                                    |  |

### 14.3 Type 2 Diabetes

A total of 479 adult patients with type 2 diabetes inadequately controlled on optimal/maximally tolerated doses of metformin only, or 2 or more oral antidiabetic (OAD) agents participated in a 24-week, double-blind, placebo-controlled study. Following a 6-week run-in period, 353 patients were randomized to AFREZZA (n=177) or an inhaled placebo powder without insulin (n=176). Insulin doses were titrated for the first 12 weeks and kept stable for the last 12 weeks of the study. OADs doses were kept stable. At Week 24, treatment with AFREZZA plus OADs provided a mean reduction in HbA1c that was statistically significantly greater compared to the HbA1c reduction observed in the placebo group (Table 6).

**Table 6. Results at Week 24 in a Placebo-Controlled Study of AFREZZA in Adults with Type 2 Diabetes Inadequately Controlled on Oral Antidiabetic Agents**

| Efficacy Parameter   | AFREZZA + Oral Anti-Diabetic Agents (N=177) | Placebo + Oral Anti-Diabetic Agents (N=176) |
|--|---|---|
| <b>HbA1c (%)</b>   |   |   |
| Baseline (adjusted mean <sup>a</sup> )   | 8.25  | 8.27  |
| Change from baseline (adjusted mean <sup>a,b</sup> )   | -0.82                                       | -0.42                                       |
| Difference from placebo (adjusted mean <sup>a,b</sup> ) (95% CI)   |   | -0.40<br>(-0.57, -0.23)                     |
| Percentage (%) of patients achieving HbA1C ≤7% <sup>c</sup>  | 32.2  | 15.3  |
| <b>Fasting Plasma Glucose (mg/dL)</b>  |   |   |
| Baseline (adjusted mean <sup>a</sup> )   | 175.9                                       | 175.2                                       |
| Change from baseline (adjusted mean <sup>a,b</sup> )   | -11.2                                       | -3.8  |
| Difference from placebo (adjusted mean <sup>a,b</sup> ) (95% CI)   |   | -7.4<br>(-18.0, 3.2)                        |
| <sup>a</sup> Adjusted mean was obtained using a Mixed Model Repeated Measures (MMRM) approach with HbA1c or FPG as the dependent variable and treatment, visit, region, and treatment by visit interaction as fixed factors, and corresponding baseline as a covariate. An autoregression (1) [AR(1)] covariance structure was used.<br><sup>b</sup> Data at 24 weeks without rescue therapy were available from 139 (79%) and 129 (73%) subjects randomized to the AFREZZA and placebo groups, respectively.<br><sup>c</sup> The percentage was calculated based on the number of patients randomized to the trial. |   |   |

## 16 HOW SUPPLIED/STORAGE AND HANDLING

AFREZZA (insulin human) Inhalation Powder is available as 4 unit, 8 unit and 12 unit single-use cartridges. Three cartridges are contained in a single cavity of a blister strip. Each card contains 5 blister strips separated by perforations for a total of 15 cartridges. For convenience, the perforation allows users to remove a single strip containing 3 cartridges. Two cards of the same cartridge strength are packaged in a foil laminate overwrap (30 cartridges per foil package).

The cartridges are color-coded, blue for 4 units, green for 8 units and yellow for 12 units. Each cartridge is marked with “afrezza” and “4 units”, “8 units” or “12 units”.

The AFREZZA Inhaler is individually packaged in a clear overwrap. The inhaler is fully assembled with a removable mouthpiece cover. The AFREZZA Inhaler can be used for up to 15 days from the date of first use. After 15 days of use, the inhaler must be discarded and replaced with a new inhaler.

AFREZZA is available in the following configurations:

- NDC 47918-874-90, AFREZZA (insulin human) Inhalation Powder: 90 – 4 unit cartridges and 2 inhalers
- NDC 47918-878-90, AFREZZA (insulin human) Inhalation Powder: 90 – 8 unit cartridges and 2 inhalers
- NDC 47918-891-90, AFREZZA (insulin human) Inhalation Powder: 90 – 12 unit cartridges and 2 inhalers
- NDC 47918-898-18, AFREZZA (insulin human) Inhalation Powder; 180 cartridges; 90 – 8 unit cartridges and 90 – 12 unit cartridges and 2 inhalers
- NDC 47918-880-18, AFREZZA (insulin human) Inhalation Powder; 180 cartridges; 90 – 4 unit cartridges and 90 – 8 unit cartridges and 2 inhalers (Titration Pack)
- NDC 47918-902-18, AFREZZA (insulin human) Inhalation Powder; 180 cartridges; 60 – 4 unit cartridges, 60 – 8 unit cartridges and 60 – 12 unit cartridges and 2 inhalers (Titration Pack)

### Storage:

Not in Use: Refrigerated Storage 2-8°C (36-46°F)

|  |  |
|--|--|
| Sealed (Unopened) Foil Package           | May be stored until the Expiration Date* |
| Sealed (Unopened) Blister Cards + Strips | Must be used within 1 month*             |

\* If a foil package, blister card or strip is not refrigerated, the contents must be used within 10 days.

In Use: Room Temperature Storage 25°C (77°F), excursions permitted 15-30°C (59-86°F)

|  |                             |
|--|-----------------------------|
| Sealed (Unopened) Blister Cards + Strips | Must be used within 10 days |
| Opened Strips                            | Must be used within 3 days  |

Do not put a blister card or strip back into the refrigerator after being stored at room temperature.

### Inhaler Storage:

Store at 2-25°C (36-77°F); excursions permitted. Inhaler may be stored refrigerated, but should be at room temperature before use.

### Handling:

Before use, cartridges should be at room temperature for 10 minutes.

## 17 PATIENT COUNSELING INFORMATION

Advise the patient to read the FDA-approved patient labeling (Medication Guide and Instructions for Use).

### Instructions

Instruct patients to read the Medication Guide before starting AFREZZA therapy and to reread it each time the prescription is renewed, because information may change. Instruct patients to inform their healthcare provider or pharmacist if they develop any unusual symptom, or if any known symptom persists or worsens.

Inform patients of the potential risks and benefits of AFREZZA and of alternative modes of therapy. Inform patients about the importance of adherence to dietary instructions, regular physical activity, periodic blood glucose monitoring and HbA1c testing, recognition and management of hypoglycemia and hyperglycemia, and assessment for diabetes complications. Advise patients to seek medical advice promptly during periods of stress such as fever, trauma, infection, or surgery, as medication requirements may change.

Instruct patients to use AFREZZA only with the AFREZZA inhaler.

Inform patients that the most common adverse reactions associated with the use of AFREZZA are hypoglycemia, cough, and throat pain or irritation.

Advise women with diabetes to inform their physician if they are pregnant or are planning to become pregnant while using AFREZZA.

#### **Acute Bronchospasm in Patients with Chronic Lung Disease**

Advise patients to inform their physicians if they have a history of lung disease, because AFREZZA should not be used in patients with chronic lung disease (e.g., asthma, COPD, or other chronic lung disease(s)) [see *Contraindications (4) and Warnings and Precautions (5.1)*].

Advise patients that if they experience any respiratory difficulty after inhalation of AFREZZA, they should report it to their physician immediately for assessment.

#### **Hypoglycemia**

Instruct patients on self-management procedures including glucose monitoring, proper inhalation technique, and management of hypoglycemia and hyperglycemia especially at initiation of AFREZZA therapy. Instruct patients on handling of special situations such as intercurrent conditions (illness, stress, or emotional disturbances), an inadequate or skipped insulin dose, inadvertent administration of an increased insulin dose, inadequate food intake, and skipped meals.

Instruct patients on the management of hypoglycemia. Inform patients that their ability to concentrate and react may be impaired as a result of hypoglycemia. Advise patients who have frequent hypoglycemia or reduced or absent warning signs of hypoglycemia to use caution when driving or operating machinery [see *Warnings and Precautions (5.3)*].

#### **Decline in Pulmonary Function and Monitoring**

Inform patients that AFREZZA can cause a decline in lung function and their lung function will be evaluated by spirometry before initiation of AFREZZA treatment [see *Warnings and Precautions (5.4)*].

#### **Lung Cancer**

Inform patients to promptly report any signs or symptoms potentially related to lung cancer [see *Warnings and Precautions (5.5)*].

#### **Diabetic Ketoacidosis**

Instruct patients to carefully monitor their blood glucose during illness, infection, and other risk situations for diabetic ketoacidosis and to contact their healthcare provider if their blood glucose control worsens [see *Warnings and Precautions (5.6)*].

#### **Hypersensitivity Reactions**

Advise patients that hypersensitivity reactions can occur with insulin therapy including AFREZZA. Inform patients on the symptoms of hypersensitivity reactions [see *Warnings and Precautions (5.7)*].

AFREZZA is a registered trademark of MannKind Corporation  
Patented. See <http://www.mannkindcorp.com/patent-notice>  
MannKind Corporation, Danbury, CT 06810